

ELECTRICAL OPTIONS/ SPECIFICATIONS

OUTPUT SUPPLY
 0.5 TO 4.5V RATIO METRIC 5V
 SUPPLY CURRENT 12mA TYP. 20mA MAX.

CABLE: 0.2mm², O/A SCREEN, PUR JACKET – SUPPLIED WITH 50cm OR REQUIRED LENGTH IN cm (15000cm MAX).
 STANDARD 3-CORE: JACKET Ø4mm BLACK e.g. 'L50'
 OPTIONAL 5-CORE: JACKET Ø4.6mm BLUE e.g. 'LQ50'

CABLE/CONNECTOR* CONNECTIONS;

3 CORE	5 CORE	CONNECTOR	
RED	RED	:1	+Ve
-	ORG	:1	+SENSE (5-WIRE ONLY)
BLACK	BLACK	:3	0V
-	GRY	:3	-SENSE (5-WIRE ONLY)
WHITE	WHITE	:2	OUTPUT
SCREEN	SCREEN	:4	BODY

*CONNECTORS; MAXIMUM CONDUCTOR CROSS SECTION 0.25mm²
 RANGE OF DISPLACEMENT FROM 0–15° TO 0–160° e.g. 76°, IN INCREMENTS OF 1°.

BODY MATERIAL:- STAINLESS STEEL.
 FLANGE BASE MATERIAL:- STAINLESS STEEL.
 SERVO MOUNT MATERIAL:- STAINLESS STEEL.

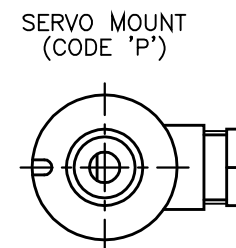
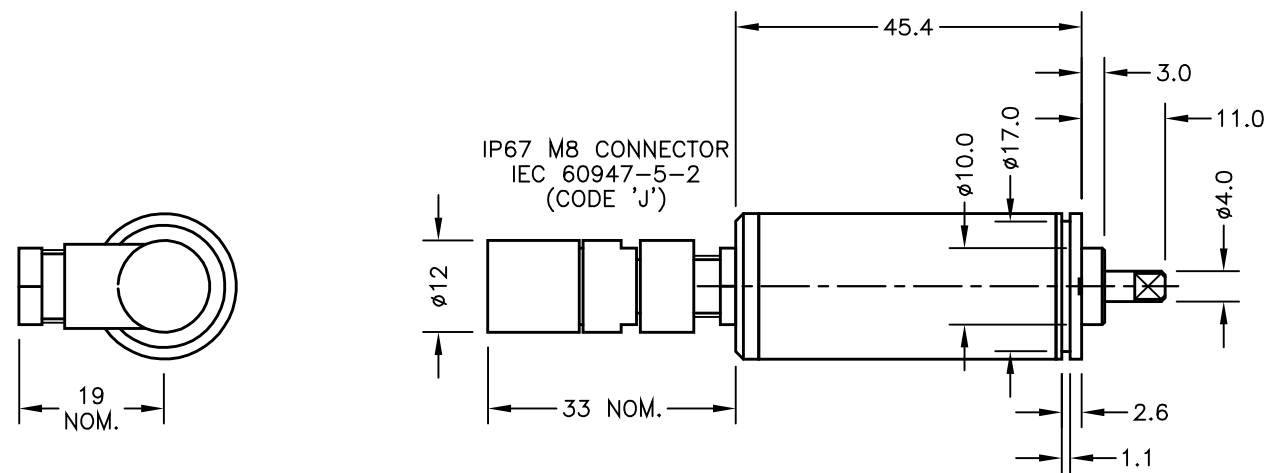
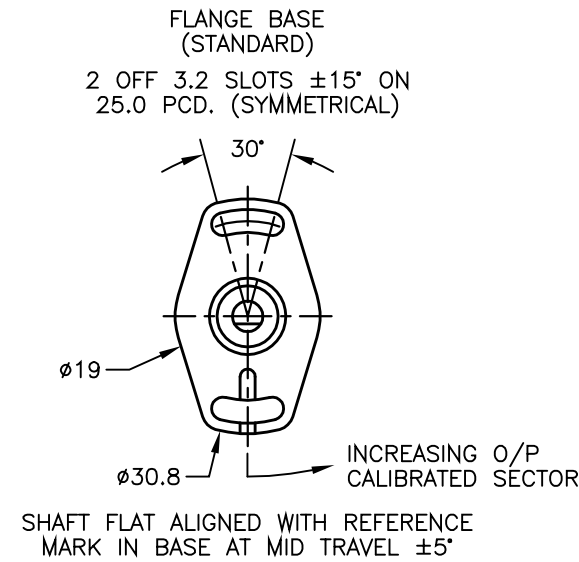
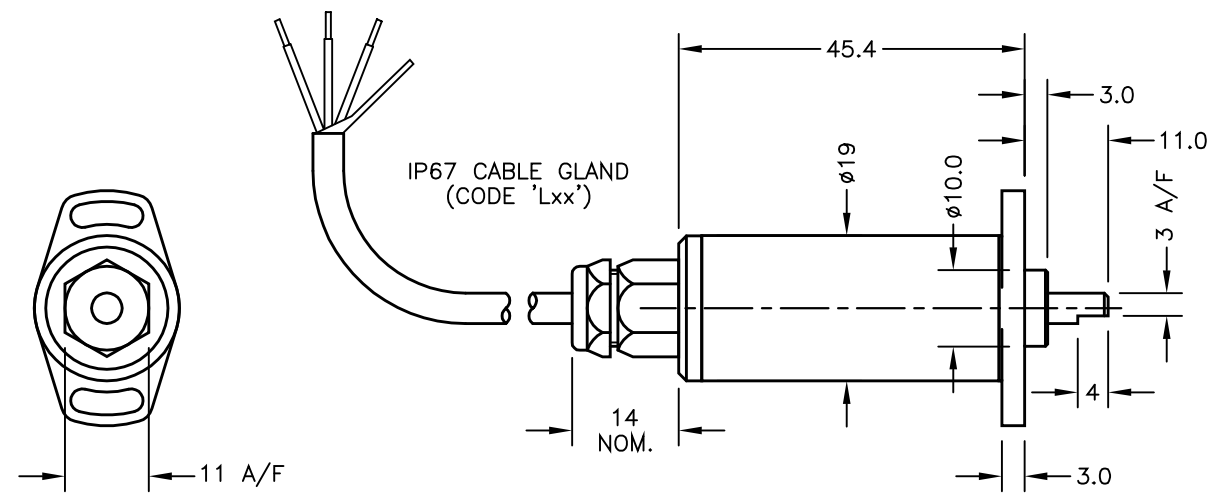

NOTE:- READ INSTALLATION SHEET E505-19 FOR FULL INSTRUCTIONS FOR USE.

ATEX / IECEx APPROVED TO
 II 1GD
 Ex ia IIC T4 Ga (Ta= -40° to +80°C)
 Ex ia IIIC T135°C Da (Ta= -40° to +80°C)
 Ui 11.4V, li 0.2A, Pi 0.51W

APPROVED FOR USE IN CONJUNCTION WITH A GALVANICALLY ISOLATED BARRIER.

NOTE: APPROVAL ONLY APPLIES AT NORMAL ATMOSPHERIC PRESSURE!



A	FIRST ISSUE	RDS
B	RANGE WAS 20° TO 160° RAN 442	RDS
C	APPROVAL STANDARDS UPDATED - RAN465.	PDM
D	SHAFT LENGTH REDUCED 0.5 - RAN538.	PDM
E	OPTION 'J' ADDED - RAN1068.	PDM
F	5-CORE OPTION ADDED ~ RAN1102	PDM
G	RANGE NOTE AMENDED ~ RAN1200	PDM



DRAWINGS NOT TO BE CHANGED WITHOUT REFERENCE TO THE CHANGE PROCEDURE.
 CHANGES TO PARTS USED IN INTRINSICALLY SAFE PRODUCT MUST BE APPROVED BY THE AUTHORISED PERSON
 THIS IS AN UNCONTROLLED PRINT AND WILL NOT BE UPDATED.

POSITEK

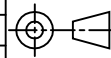
LIMITED

A	31/01/12	 CHECKED BY X RDS	X ±0.4
B	20/11/13		X.X ±0.2
C	12/03/14		X.XX ±0.1
D	21/01/15	DESCRIPTION	
E	02/12/15	E505 INTRINSICALLY SAFE	
F	27/04/17	SLIM-LINE ROTARY SENSOR	
G	12/09/17		
SCALE 5mm		DRAWING NUMBER E505-11 REV G	
		SHEET 1 OF 1	